



YDS-USB2A-FF-OV9734 V2.0

1MP OmniVision OV9734 Fixed Focus USB 2.0 Endoscope Camera Module



YDS-USB1A-FF-OV9734 V2.0 is a 1MP Fixed Focus USB camera module based on 1/9" OV9734 image sensor. It delivers high-speed, 1280 x 720 resolution ultra sharp image. The compact size lens enables fitting in small tube. This camera module is ideal solution for endoscope.

Key Features

- 1280 x 720 OmniVision OV9734 sensor
- High speed USB 2.0 Plug and Play
- MJPEG and YUV2 output format
- Low power consumption
- Compact size for endoscope
- UVC compliant to Windows, Linux, OS with UVC driver
- USB OTG (On-The-Go) support



YDS CAMERA MODULE

your best camera partner

YDS-USB2A-FF-OV9734 V2.0

1MP OmniVision OV9734 Fixed Focus USB 2.0 Endoscope Camera Module

Camera Module No.	YDS-USB2A-FF-OV9734 V2.0
Resolution	1MP
Image Sensor	OV9734
Sensor Type	1/9"
Pixel Size	1.4 um x 1.4 um
EFL	1.03 mm
F.NO	4.70
Pixel	1280 x 720
View Angle	88.0°(DFOV) 80.0°(HFOV) 50.5°(VFOV)
Lens Dimensions	Φ3.5 mm
Module Type	Fixed Focus
Interface	USB 2.0
Output Format	MJPEG / YUV2
Auto Control	Saturation, Contrast, Acutance White Balance, Exposure
Audio	None
Input Voltage	DC 5V
Working Current	Max 500mA
PCB Size	37.00 x 18.00 mm
System Compatibility	Windows XP (SP2, SP3), Vista, 7, 8, 10, 11 Android, Mac OS, Linux or OS with UVC Driver Raspberry Pi by USB Port
Software for USB Camera	AMCAP, Webcam Viewer, V4L2 Controls Contacam, VLC Player, MotionEye OS iSpy, ZoneMider, Yawcam
Lens Type	650nm IR Cut
Operating Temperature	-30°C to +85°C
USB Cable	USB Cable

Wide Compatibility with Windows, Android, Mac OS, Linux, or Raspberry Pi



www.YDSCAM.com sales@ydscam.com Phone (WeChat, QQ): (+86) 177 2732 6718

All rights reserved @ YingDeShun Co. Ltd. Specifications subject to change without notice.



YDS-USB2A-FF-OV9734 V2.0

1MP OmniVision OV9734 Fixed Focus USB 2.0 Endoscope Camera Module

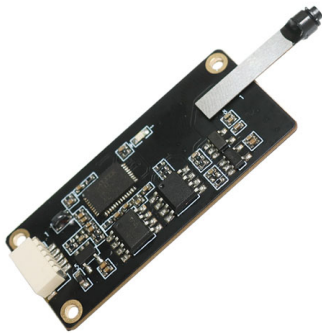

Top View

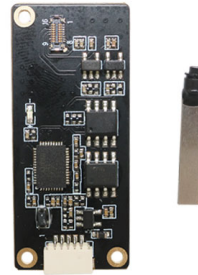

Side View

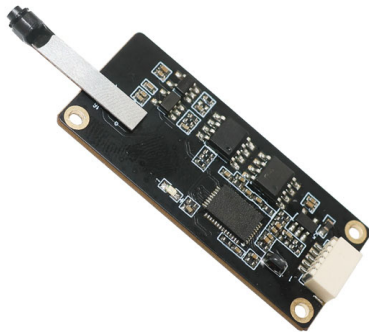

Bottom View



USB Cable

YDS-USB2A-FF-OV9734 V2.0

1MP OmniVision OV9734 Fixed Focus USB 2.0 Endoscope Camera Module

FORMAT	RESOLUTION	FRAME RATE
		USB 2.0
MJPG	320 x 240	30 FPS
	640 x 480 (VGA)	30 FPS
	1280 x 720 (720P)	30 FPS
YUV2	320 x 240	30 FPS
	640 x 480 (VGA)	30 FPS
	1280 x 720 (720P)	10 FPS



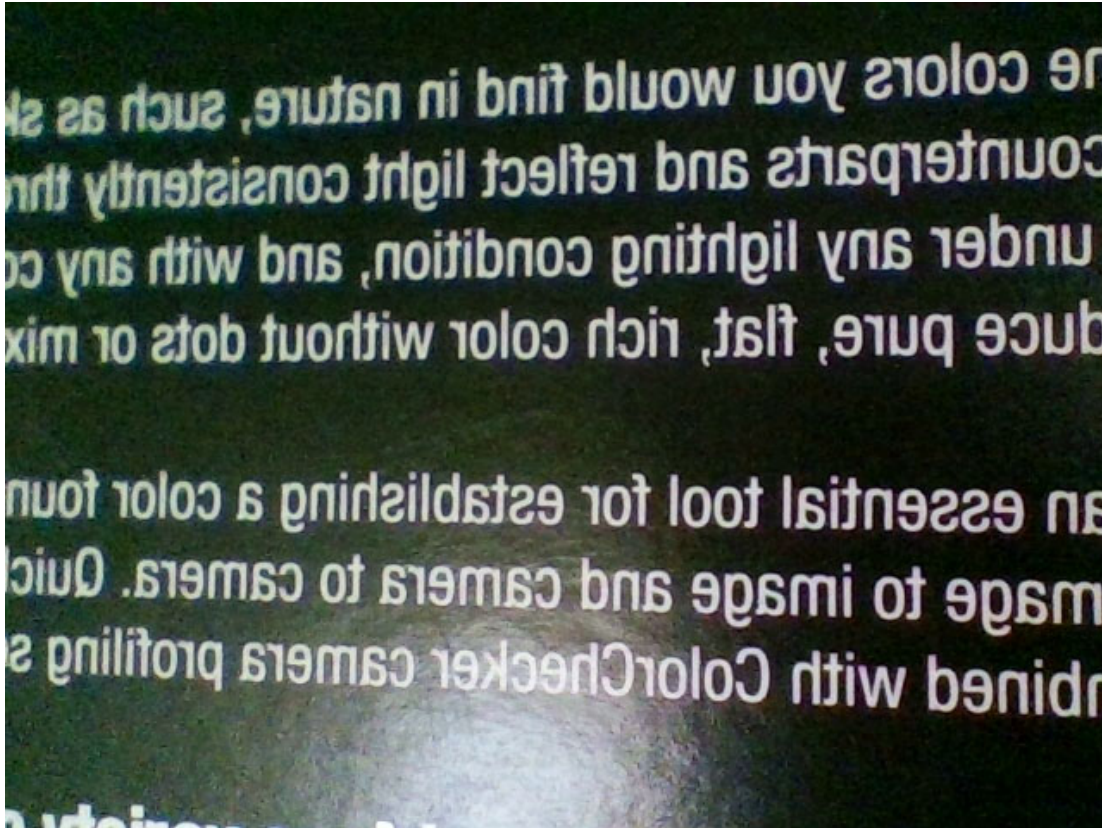

RoHS	
PIN	SIGNAL
1	MCN
2	MCP
3	DGND
4	MDN0
5	MDP0
6	DGND
7	SCL
8	SDA
9	XCLK
10	DGND
11	DGND
12	DVDD 1.2V
13	DOVDD 1.8V
14	AVDD 2.8V
15	PWDN
16	NC

Version	Information
V1.0	First Version
V2.0	Change lens

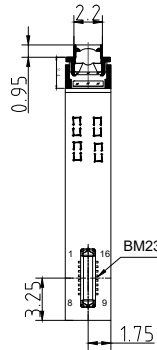
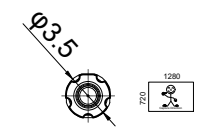

TOP VIEW

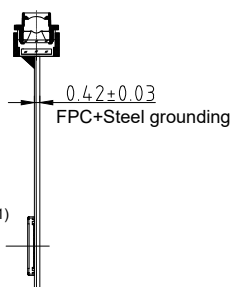

SIDE VIEW

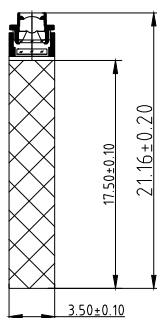

BOTTOM VIEW

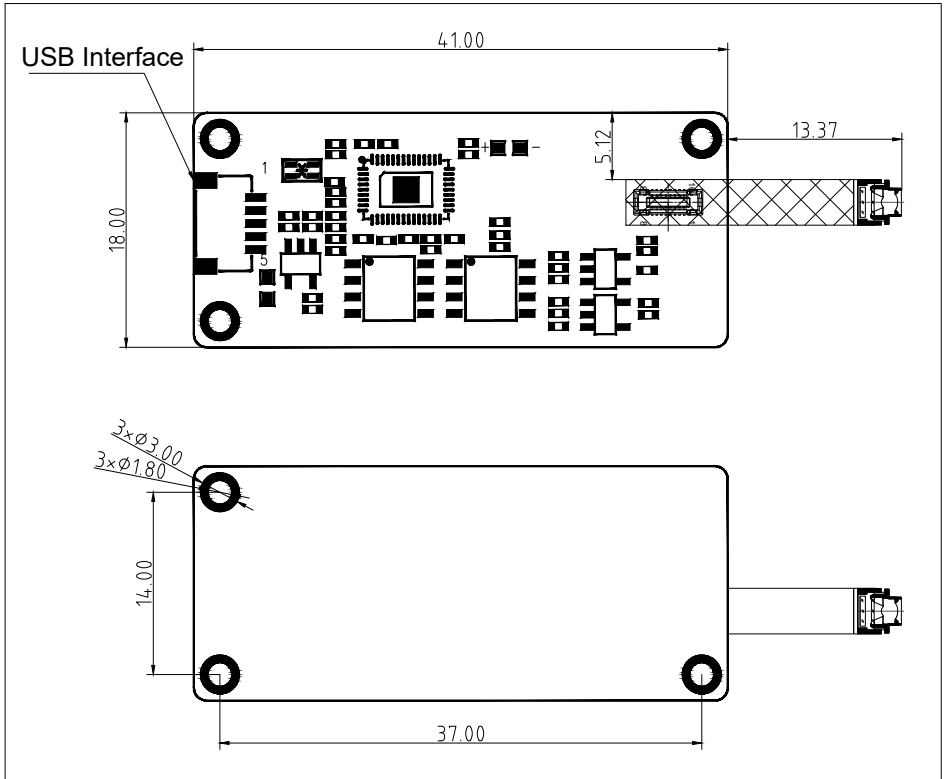

Parameters:

1、 Sensor specification:
 Image Sensor: OV9734
 Pixel: 1.4um*1.4um
 Lens Type: 1/9
 Important Voltage Description:
 USB 5V (external power supply);

2、 Lens specification:
 FOV: 88°(D);80°(H);50.5°(V);
 F/NO.: 4.7
 TV distortion: <1.3%
 Focal length: 1.03mm
 Composition: 3P+IR FILTER
 IR Cut Coating: 650nm±10nm@50%

Designed By	Kevin	Model Name:	USB2A-FF-OV9734 V2.0		
Checked By	Jacky	Projection Type:	Unit:	Date:	
			mm	3/8/2024	
			Scale:	Sheet:	Version:
			1:1	1 of 1	1/0

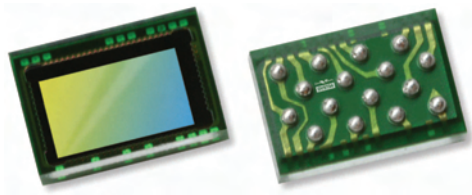

OV9734-OV9234 720p HD product brief



OmniVision's Smallest 720p High Definition Sensor for Next-Generation Notebooks and Mobile Devices



available in
a lead-free
package

The OV9734 is an ultra-compact and power efficient CameraChip™ image sensor designed for slim notebooks, tablets, handsets, and other devices that require a thin bezel. Built on OmniVision's PureCel® technology, the OV9734 CameraChip™ delivers premium quality images and video, while consuming significantly less power than previous generation image sensors.

OmniVision's 1/9-inch OV9734 is capable of capturing crisp 720p HD video at 30 frames per second (fps) or VGA video at 45 fps, while consuming approximately 25 percent less power than the previous generation 720p sensor. Additionally, the OV9734 meets the video quality specifications for popular video conferencing platforms.

To fit ultra-thin bezel devices, the OV9734 comes in a compact package that can meet 2.5 mm z-height and is 47 percent smaller in y-dimension compared to the previous generation 720p sensor.

The OV9234, a black and white version of the OV9734, is also available as a dedicated IR camera solution for facial recognition and other biometric applications. Both sensors are available in CSP and COB packaging.

Find out more at www.ovt.com.



Applications

- Smartphones
- PC Multimedia
- Tablets
- Digital Still Cameras
- Toys

Product Features

- support for image sizes:
 - full size (1280x720)
 - VGA (640x480)
 - 2x2 RGB binning (640x360)
 - 2x2 B&W binning (640x360)
- support for output formats: RAW output with 1-lane MIPI
- on-chip phase lock loop (PLL)
- capable of maintaining register values at software power down
- programmable controls for:
 - frame rate
 - mirror and flip
 - gain/exposure
 - windowing
- support for horizontal and vertical sub-sampling
- automatic black level calibration (ABLC)
- defect pixel correction (DPC)
- support for black sun cancellation
- standard SCCB interface
- GPIO tri-state configurability and programmable polarity

OV9734-OV9234

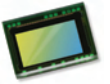

Ordering Information

- OV9734-H16A-2A (color, lead-free, 16-pin CSP)
- OV9234-H16A (b&w, lead-free, 16-pin CSP)

Product Specifications

- active array size: 1280 x 720
- scan mode: progressive
- power supply:
 - core: 1.2VDC $\pm 5\%$
 - analog: 2.6 - 3.0V (2.8V normal)
 - I/O: 1.8V
- power requirements:
 - active: 69 mW
 - XSHUTDOWN: 0.9 μ W
- temperature range:
 - operating: -30°C to +85°C junction temperature
 - stable image: 0°C to +50°C junction temperature
- output formats: 10-bit RAW RGB
- lens size: 1/9"
- lens chief ray angle: 32.1°
- input clock frequency: 6 - 27 MHz
- maximum image transfer rate: 30 fps
- sensitivity: 585 mV/Lux-sec
- shutter: rolling shutter
- max S/N ratio: 36.4 dB
- dynamic range: 68.4 dB @ 16x gain
- maximum exposure interval: 798 x t_{row}
- pixel size: 1.4 μ m x 1.4 μ m
- dark current: 2 e^- /sec @ 50°C junction temperature
- image area: 1819.58 μ m x 1033.34 μ m
- package dimensions: 2532 μ m x 1722 μ m

Functional Block Diagram

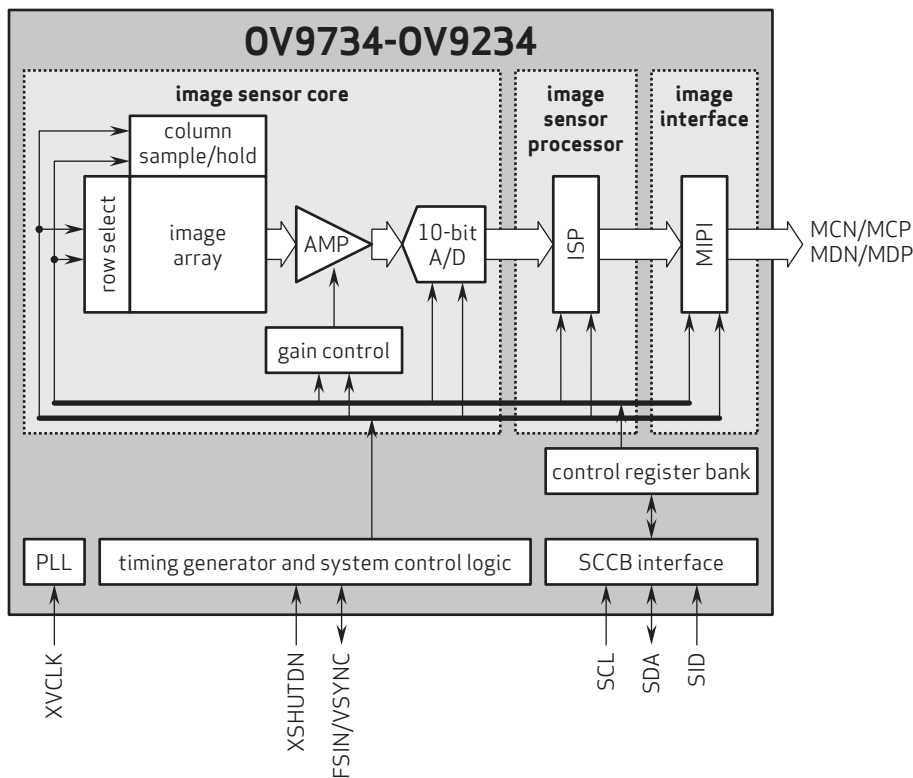

4275 Burton Drive
Santa Clara, CA 95054
USA

Tel: + 1 408 567 3000
Fax: + 1 408 567 3001
www.ovt.com

OmniVision reserves the right to make changes to their products or to discontinue any product or service without further notice. OmniVision, the OmniVision logo, and PureCel are registered trademarks of OmniVision Technologies, Inc. CameraChip is a trademark of OmniVision Technologies, Inc. All other trademarks are the property of their respective owners.



OmniVision

Cameras Applications



Automotive Driver Pilot



Live Streaming



Video Conference



Eye Tracker Biometric Detection

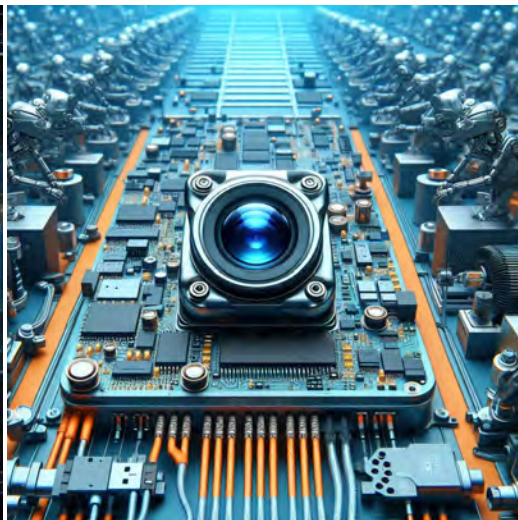

Machine Vision



Agricultural Monitor



Night Vision Security



Drone and Sports Eagle Eyes



Interactive Pet Camera



YDS CAMERA MODULE

your best camera partner

Camera Module Pinout Definition Reference Chart

OmniVision	Sony	Samsung	On-Semi	Aptina	Himax	GalaxyCore	PixArt	SmartSens	Sensors
Pin Signal		Description							
DGND GND		ground for digital circuit							
AGND		ground for analog circuit							
PCLK DCK		DVP PCLK output							
XCLR PWDN XSHUTDOWN STANDBY		power down active high with internal pull-down resistor							
MCLK XVCLK XCLK INCK		system input clock							
RESET RST		reset active low with internal pull-up resistor							
NC NULL		no connect							
SDA SIO_D SIOD		SCCB data							
SCL SIO_C SIOC		SCCB input clock							
VSYNC XVS FSYNC		DVP VSYNC output							
HREF XHS		DVP HREF output							
DOVDD		power for I/O circuit							
AFVDD		power for VCM circuit							
AVDD		power for analog circuit							
DVDD		power for digital circuit							
STROBE FSTROBE		strobe output							
FSIN		synchronize the VSYNC signal from the other sensor							
SID		SCCB last bit ID input							
ILPWM		mechanical shutter output indicator							
FREQ		frame exposure / mechanical shutter							
GPIO		general purpose inputs							
SLASEL		I2C slave address select							
AFEN		CEN chip enable active high on VCM driver IC							
MIPI Interface									
MDN0 DN0 MD0N DATA_N DMO1N		MIPI 1st data lane negative output							
MDP0 DP0 MD0P DATA_P DMO1P		MIPI 1st data lane positive output							
MDN1 DN1 MD1N DATA2_N DMO2N		MIPI 2nd data lane negative output							
MDP1 DP1 MD1P DATA2_P DMO2P		MIPI 2nd data lane positive output							
MDN2 DN2 MD2N DATA3_N DMO3N		MIPI 3rd data lane negative output							
MDP2 DP2 MD2P DATA3_P DMO3P		MIPI 3rd data lane positive output							
MDN3 DN3 MD3N DATA4_N DMO4N		MIPI 4th data lane negative output							
MDP3 DP3 MD3P DATA4_P DMO4P		MIPI 4th data lane positive output							
MCN CLKN CLK_N DCKN		MIPI clock negative output							
MCP CLKP MCP CLK_P DCKN		MIPI clock positive output							
DVP Parallel Interface									
D0 DO0 Y0		DVP data output port 0							
D1 DO1 Y1		DVP data output port 1							
D2 DO2 Y2		DVP data output port 2							
D3 DO3 Y3		DVP data output port 3							
D4 DO4 Y4		DVP data output port 4							
D5 DO5 Y5		DVP data output port 5							
D6 DO6 Y6		DVP data output port 6							
D7 DO7 Y7		DVP data output port 7							
D8 DO8 Y8		DVP data output port 8							
D9 DO9 Y9		DVP data output port 9							
D10 DO10 Y10		DVP data output port 10							
D11 DO11 Y11		DVP data output port 11							

www.YDSCAM.com sales@ydscam.com Phone (WeChat, QQ): (+86) 177 2732 6718

All rights reserved @ YingDeShun Co. Ltd. Specifications subject to change without notice.

Camera Reliability Test

Reliability Inspection Item		Testing Method	Acceptance Criteria	
Category	Item			
Environmental	Storage Temperature	High 60°C 96 Hours	Temperature Chamber	No Abnormal Situation
		Low -20°C 96 Hours	Temperature Chamber	No Abnormal Situation
	Operation Temperature	High 60°C 24 Hours	Temperature Chamber	No Abnormal Situation
		Low -20°C 24 Hours	Temperature Chamber	No Abnormal Situation
	Humidity	60°C 80% 24 Hours	Temperature Chamber	No Abnormal Situation
	Thermal Shock	High 60°C 0.5 Hours Low -20°C 0.5 Hours Cycling in 24 Hours	Temperature Chamber	No Abnormal Situation
Physical	Drop Test (Free Falling)	Without Package 60cm	10 Times on Wood Floor	Electrically Functional
		With Package 60cm	10 Times on Wood Floor	Electrically Functional
	Vibration Test	50Hz X-Axis 2mm 30min	Vibration Table	Electrically Functional
		50Hz Y-Axis 2mm 30min	Vibration Table	Electrically Functional
		50Hz Z-Axis 2mm 30min	Vibration Table	Electrically Functional
	Cable Tensile Strength Test	Loading Weight 4 kg 60 Seconds Cycling in 24 Hours	Tensile Testing Machine	Electrically Functional
Electrical	ESD Test	Contact Discharge 2 KV	ESD Testing Machine	Electrically Functional
		Air Discharge 4 KV	ESD Testing Machine	Electrically Functional
	Aging Test	On/Off 30 Seconds Cycling in 24 Hours	Power Switch	Electrically Functional
	USB Connector	On/Off 250 Times	Plug and Unplug	Electrically Functional



Camera Inspection Standard

Inspection Item		Inspection Method	Standard of Inspection		
Category	Item				
Appearance	FPC/ PCB	Color	The Naked Eye	Major Difference is Not Allowed.	
		Be Torn/Chopped	The Naked Eye	Copper Crack Exposure is Not Allowed.	
		Marking	The Naked Eye	Clear, Recognizable (Within 30cm Distance)	
	Holder	Scratches	The Naked Eye	The Inside Crack Exposure is Not Allowed	
		Gap	The Naked Eye	Meet the Height Standard	
		Screw	The Naked Eye	Make Sure Screws Are Presented (If Any)	
		Damage	The Naked Eye	The Inside Crack Exposure is Not Allowed	
	Lens	Scratch	The Naked Eye	No Effect On Resolution Standard	
		Contamination	The Naked Eye	No Effect On Resolution Standard	
		Oil Film	The Naked Eye	No Effect On Resolution Standard	
		Cover Tape	The Naked Eye	No Issue On Appearance.	
	Function	Image	No Communication	Test Board	Not Allowed
			Bright Pixel	Black Board	Not Allowed In the Image Center
Dark Pixel			White board	Not Allowed In the Image Center	
Blurry			The Naked Eye	Not Allowed	
No Image			The Naked Eye	Not Allowed	
Vertical Line			The Naked Eye	Not Allowed	
Horizontal Line			The Naked Eye	Not Allowed	
Light Leakage			The Naked Eye	Not Allowed	
Blinking Image			The Naked Eye	Not Allowed	
Bruise			Inspection Jig	Not Allowed	
Resolution			Chart	Follows Outgoing Inspection Chart Standard	
Color			The Naked Eye	No Issue	
Noise			The Naked Eye	Not Allowed	
Corner Dark			The Naked Eye	Less Than 100px By 100px	
Color Resolution			The Naked Eye	No Issue	
Dimension	Height	The Naked Eye	Follows Approval Data Sheet		
	Width	The Naked Eye	Follows Approval Data Sheet		
	Length	The Naked Eye	Follows Approval Data Sheet		
	Overall	The Naked Eye	Follows Approval Data Sheet		

YDSCAM Package Solutions

YDS Camera Module



Complete with Lens Protection Film

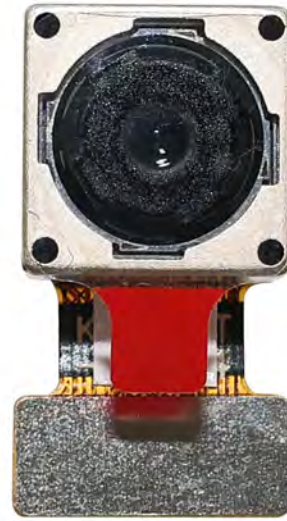

Tray with Grid and Space



Place Cameras on the Tray

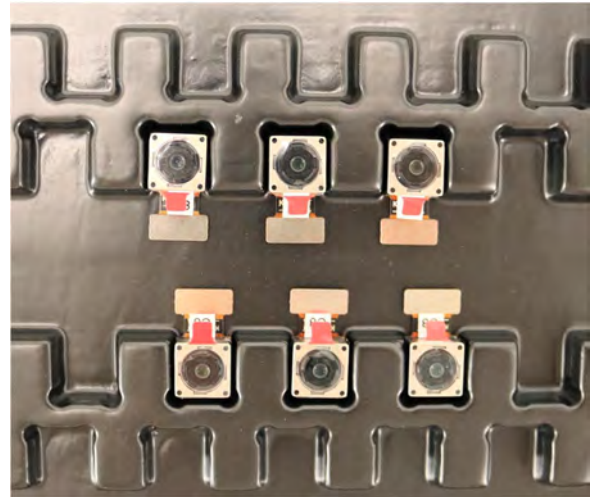

YDSCAM Package Solutions

Full Tray of Cameras

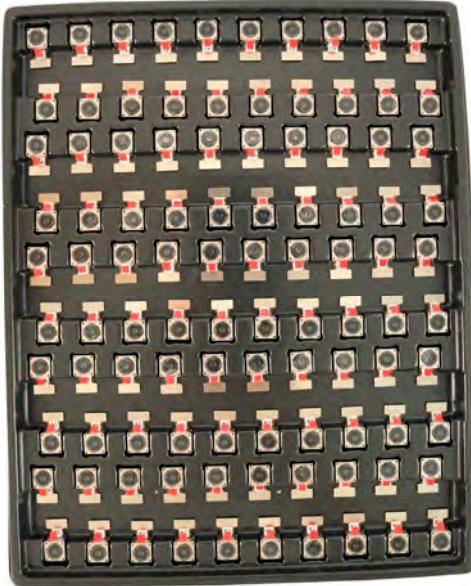

Cover Tray with Lid

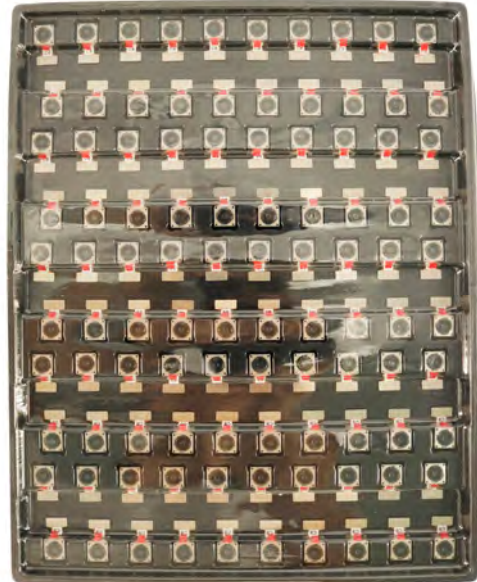

Place Tray into Anti-Static Bag



Vacuum the Anti-Static Bag



YDSCAM Package Solutions

Sealed Vacuum Anti-Static Bag with Labels

1. Model and Description 2. Quantity 3. Manufacturing Date Code 4. Caution



YDSCAM Package Solutions

Place Foam Sheets Between Tray Bags



Foam Sheets are Larger Than Trays



Place Foam Sheets and Trays into Box



Foam Sheets are Tightly Fitting in Box



Seal the Carbon Box



Label the Carbon Shipping Box





YDSCAM Package Solutions

USB Camera Module

Complete with Lens Protection Film

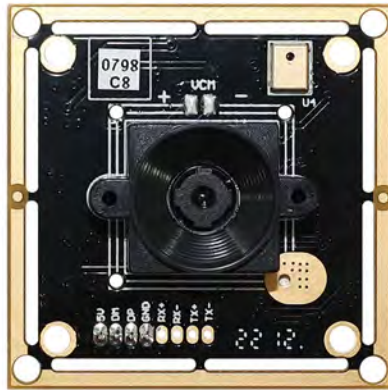

Place Camera Sample into Anti-Static Bag

Place USB Cameras into Tray



Seal the Tray with Anti-Static Bag

Label the Carbon Shipping Box



YDSCAM Package Solutions

Place Camera Sample into Anti-Static Bag



Place Connectors into Anti-Static Bag



Label the Sample Bags



Place Connectors into Reel



Place Samples into the Carbon Box



Place Connectors into the Carbon Box





YDS CAMERA MODULE

your best camera partner

Company YDSCAM

YingDeShun Co. Ltd. (YDS) was established in 2017, a next-generation technology driven manufacturer specialized in research, design, and produce of audio and video products. YDS is occupying 20,000 square feet automated plants with 100 employees of annual throughput 30,000,000 units cameras.

YDS provides OEM, ODM design, contract manufacturing, and builds the camera products. You may provide the requirements to us, even with a hand draft, our sales and engineering work together to meet your needs. We consider ourselves your last-term partner in developing practical and innovative solutions.

Our team covers everything from initial concept development to mass produced product. YDS specializes in customized camera design, raw material, electronic engineering, firmware/software development, product testing, and packing design. Our experienced strategic supply systems offer a robust and dependable manufacturing capacity for orders of various sizes.

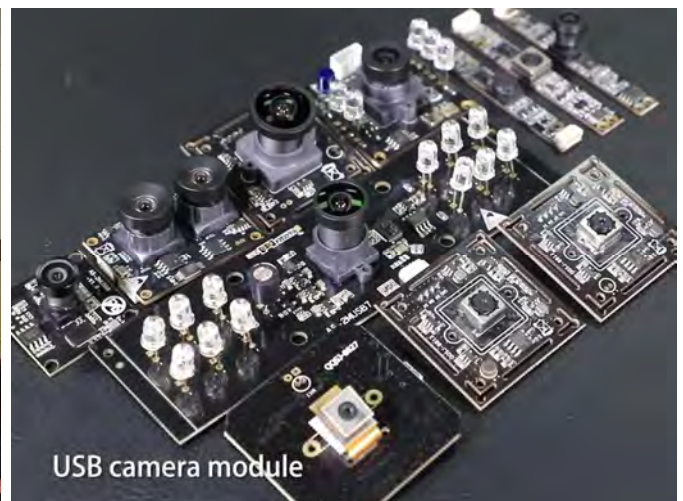

Limited Warranty

YDS provides the following limited warranty if you purchased the Product(s) directly from YDS company or from YDS's website www.YDSCAM.com. Product(s) purchased from other sellers or sources are not covered by this Limited Warranty. YDS guarantees that the Product(s) will be free from defects in materials and workmanship under normal use for a period of one (1) year from the date you receive the product ("Warranty Period").

For all Product(s) that contain or develop material defects in materials or workmanship during the Warranty Period, YDS will, at its sole option, either: (i) repair the Product(s); (ii) replace the Product(s) with a new or refurbished Product(s) (replacement Product(s) being of identical model or functional equivalent); or (iii) provide you a refund of the price you paid for the Product(s).

This Limited Warranty of YDS is solely limited to repair and/or replacement on the terms set forth above. YDS is not reliable or responsible for any subsequent events.



www.YDSCAM.com sales@ydscom.com Phone (WeChat, QQ): (+86) 177 2732 6718

All rights reserved @ YingDeShun Co. Ltd. Specifications subject to change without notice.



YDS CAMERA MODULE

your best camera partner

YDS Strength

Powerful Factory



Professional Service



Promised Delivery



www.YDSCAM.com sales@ydscam.com Phone (WeChat, QQ): (+86) 177 2732 6718

All rights reserved @ YingDeShun Co. Ltd. Specifications subject to change without notice.